

446

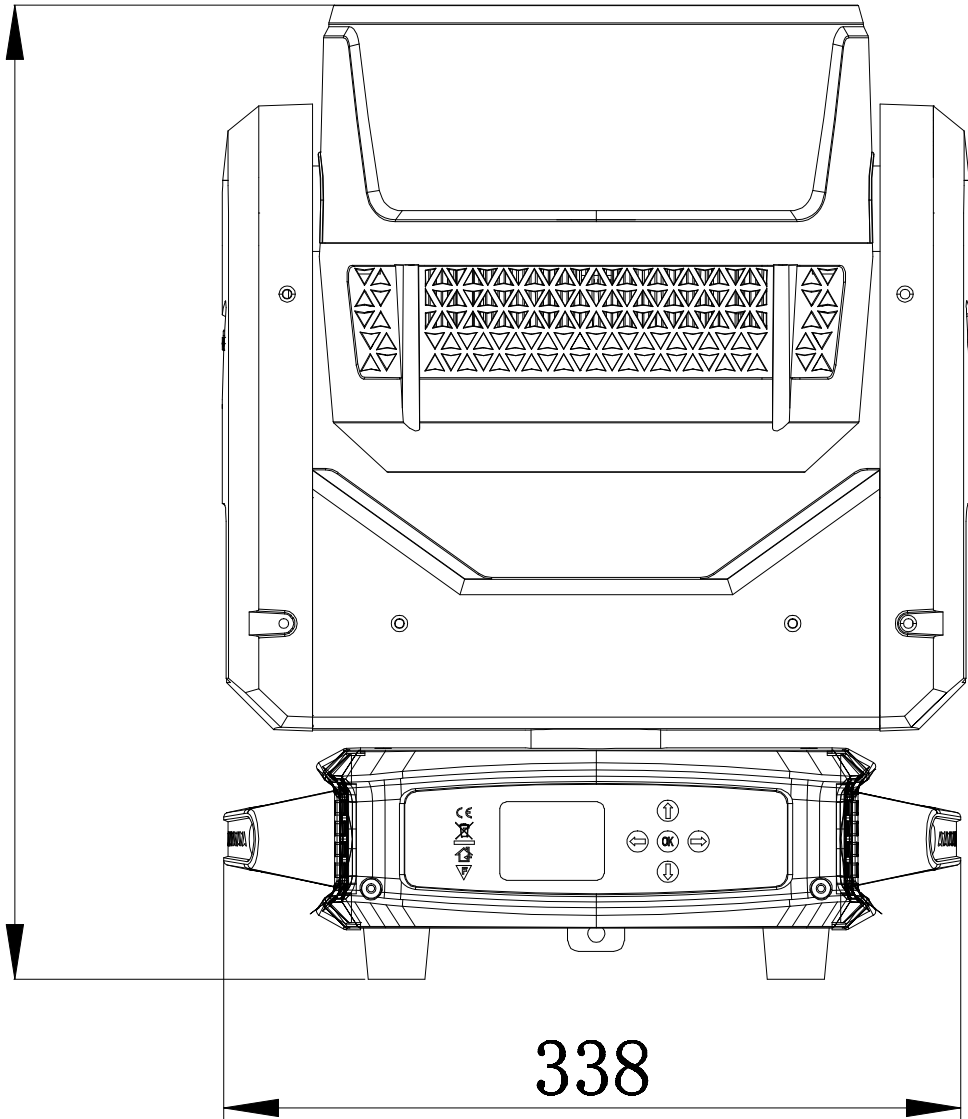

338